

Milk Cooling Systems

From 100 Lt. to 10.000 Lt.
Serial Production Milk Cooling Tanks

The Armas logo, featuring the word "armas" in a bold, blue, lowercase sans-serif font. A green swoosh is positioned above and below the text. A blue milk drop is integrated into the letter 'a'.

Custom & Serial Production Milk Cooling & Transfer Systems

* Custom designed milk cooling tanks with trailers, provides mobility in every location



* Compatible with every type of tractor or haulier
* Adjustable trailer

Armas is *Everywhere*;

Armas is a reliable partner in every step of the "Milk's Journey" From the milking to cooling, transferring finally processing, ARMAS has the best solution to all.



Custom made transferring & delivery tanks to every type trucks

Why ARMAS?

CONTROL:

With both user friendly and diversity of functions, ARMAS Milk Cooling Tanks offers easy & effective usage for users. Adjustable & reliable softwares are mounted in the product.

INSULATION:

Non-CSF environmentally safe 60 mm thickness of 141 BFCH polyurethane is used for insulation. Only 1,1 C heat lost occurs in 12 hours.

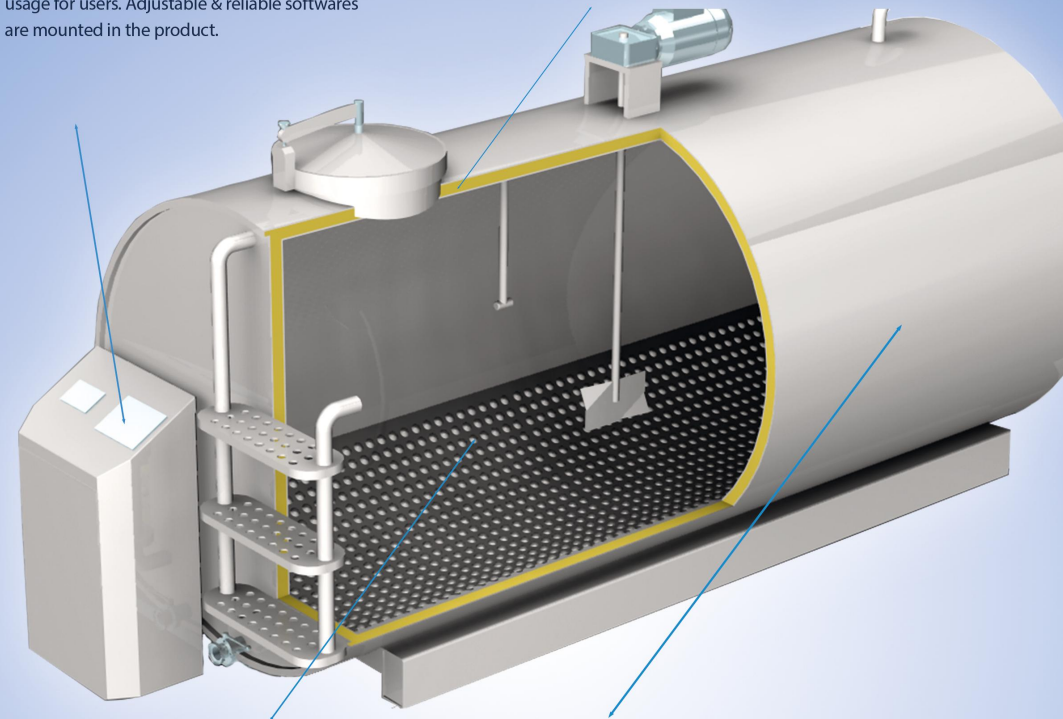

COOLER SURFACE: ROLBONT PLATE

Laser welded and 40 bars resistend rolbont plates (evaporator) is used to cool the surface. With low & wide surface area, Armas Milk Cooling Tanks is both effective and power-saving.

BODY:

In order to cool & store the milk hygienically, AISI 304 or AISI 316 materials are used to manufacture entire body. Joining points are minimized and have excellent polish work.

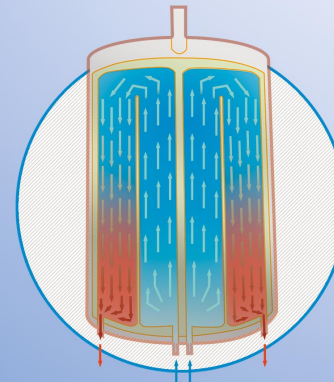

- All Tanks Store %10 - %15 More Than Stated
- Low & Wide Design Without Any Ice Problems
- Environmentally Safe Isolation Material & Cooling Gase
- 40 Bar Resistant Laser Welded Rolvont (Evaporator) Plates
- Quick & Professional After Sales Service

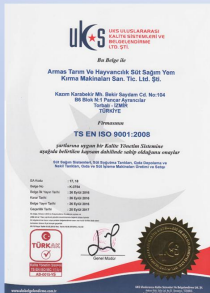

Armas has TS EN ISO 9001:2008 Quality Management System and TSE EN 13732 Quality Certificate



MINI TYPE: 100 Lt. - 300 Lt.

ARMAS MAST Series Milk Cooling Tanks are Smart Choice for Small Time Dairy Cattle Farmers.
Low Cost - High Performance - Reliable Solution

FUNDAMENTALS:

- 2BII Cooling Class
- Low noise & Ease of Use
- Compact design & No need of installation process

CONSTRUCTION:

- Complete AISI 304 or AISI 316 made body
- Laser welded rolbont plates (evaporator) for surface cooling (Tested for 40 bar pressure)
- Environmentally safe, (No CSF added) 50 mm, 141 BFCH Polyurethane is used for insulation. (1,1°C Heat loss in 12 hours.)
- Excellent polished joining points
- Less Than 0,2 Liters Left in the container after the emptying

COOLING SYSTEM:

- EU or American made Scroll type compressors
- Highly efficient cooling fans
- Condensers that provides extensive heat exchange even in extreme heat conditions.
- No ice problems in low levels of milk
- R404A Cooling Gase
- Programmed to keep the milk in temperatures between 4°C - 6°C (Adjustable)

ELECTRICAL SYSTEM:

- Digital instant temperature screen
- 220-240 Volt input powered
- Phase relays and fail switches for compressors
- Manual mode for agitator, for sampling purposes.

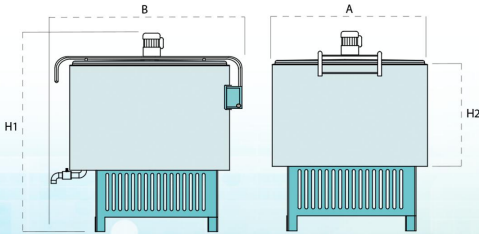

Hacim:	Kod:	A (mm)	B (mm)	H1 (mm)	H2 (mm)
100 Lt.	MAST/0	770	920	1120	420
200 Lt.	MAST/1	770	920	1370	670
300 Lt.	MAST/2	1000	1220	1270	570



VERTICAL TYPE: 500 Lt. -2000Lt.

ARMAS DAST Series Milk Cooling Tanks Offers Efficient & Low Cost Cooling with Easy Operation Efforts.
Easy Use - Easy Clean - Efficient Cooling

FUNDAMENTALS:

- 2BII Cooling Class
- Low & Wide designed body is providing more contact with surface cooling plate

CONSTRUCTION:

- Complete AISI 304 or AISI 316 made body
- Spring powered single piece cover lid
- Laser welded rolbont paltes (evaporator) for surface cooling
- Environmentally safe (No CSF added) 50 mm,141 BFCH Polyurethane is used for instulation
- (1,1°C Heat Loss in 12 Hours)
- Excellent polished joing points
- DN50 Butterfly valve is used for milk out

COOLING SYSTEM:

- EU or American made Scroll type compressors
- Highly efficient cooling fans
- Condensers that provides extensive heat exchange even in extreme heat conditions.
- Programmed to keep the milk in temperatures between 4°C - 6°C (Adjustable)
- R404 A Cooling gase

ELECTRICAL SYSTEM:

- Digital instant temperature screen
- 220-240 Volt or 380-400 Volt input powered
- Phase relays and fail switches for both compressors and agitator
- Manual mode for agitator, for sampling purposes.

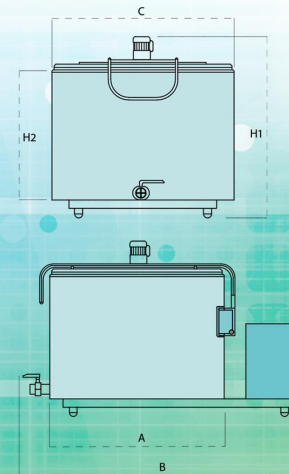

Hacim:	Kod:	A (mm)	B (mm)	C (mm)	H1 (mm)	H2 (mm)
500 Lt.	DAST/1	1250	2000	1250	970	620
750 Lt.	DAST/2	1250	2000	1250	1170	820
1.000 Lt.	DAST/3	1500	2150	1500	1130	780
1.500 Lt.	DAST/4	1500	2150	1500	1470	1120
2.000 Lt.	DAST/5	1690	2400	1690	1570	1220



SEMI-OPEN TYPE: 2000 Lt- 3000 Lt.

ARMAS YAST Series Milk Cooling Tanks Offers Efficient Cooling Process and Simplified Usage for Professional Dairy Cattle Farms. Wide Designed Rolbont Plates Ensures Extensive Cooling Performance

FUNDAMENTALS:

- 2Bll Cooling Class
- Dual designed lids provide low operation efforts
- High & Wide designed rolbont plates ensures extensive cooling performance

CONSTRUCTION:

- Complete AISI 304 or AISI 316 made body
- Laser welded rolbont paltes (evaporator) for surface cooling
- Dual designed cover lids
- Environmentally safe (No CSF added) 50 mm,141 BFCH Polyurethane is used for instulation (1,1°C Heat Loss in 12 Hours)
- Excellent polished joing points
- DN50 Butterfly valve is used for milk out

COOLING SYSTEM:

- EU or American Made Scroll type compressors
- Highly efficient cooling fans
- Condensers that provides extensive heat exchange even in extreme heat conditions.
- Programmed to keep the milk in temperatures between 4°C - 6°C (Adjustable)
- R404 A Cooling gase

ELECTRICAL SYSTEM:

- Digital instant temperature screen
- Phase relays and fail switches for both compressors and agitator
- Manual mode for agitator, for sampling purposes.

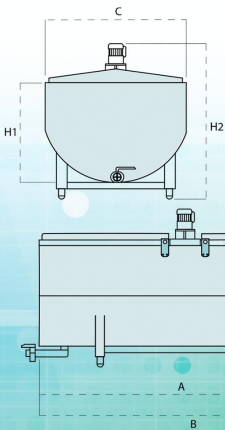

Hacim:	Kod:	A (mm)	B (mm)	C (mm)	H1 (mm)	H2 (mm)
2.000 Lt.	YAST/1	2600	3350	1397	870	1250
2.500 Lt.	YAST/2	2600	4000	1397	1070	1450
3.000 Lt.	YAST/3	3000	4000	1397	1070	1450

CYLINDRICAL TYPE: 3000 Lt - 10000 Lt.

ARMAS SAST Series Milk Cooling Tanks are Designed for Demanding Dairy Cattle Farms. AUTO WASH System is a Default Feature in SAST Series That Provides, Easy-Effective-Low Cost Cleaning With a Touch of a Button.

FUNDAMENTALS:

- 2Bll Cooling Class
- Standard digital weight / liter scale
- Standard ARMAS-AUTO Washing System with 4 main programs
- Correct sensitive ratio of cleaning acid & detergent mixing with automatic dosing pumps.
- User friendly software

CONSTRUCTION:

- Complete AISI 304 or AISI 316 made body
- Laser welded rolbont paltes (evaporator) for surface cooling
- Environmentally safe (No CSF added) 60 mm,141 BFCH Polyurethane is used for instulation (1,1°C Heat Loss in 12 Hours)
- Excellent polished joing points
- DN50 Butterfly valve is used for milk out

COOLING SYSTEM:

- EU or American Made Scroll type compressors
- Highly efficient cooling fans
- Condensers that provides extensive heat exchange even in extreme heat conditions.
- Programmed to keep the milk in temperatures between 4°C - 6°C (Adjustable)
- R404 A Cooling gase

ELECTRICAL SYSTEM:

- Digital screen for ARMAS AUTOWASH System
- Digital instant temperature screen
- Phase relays and fail switches for both compressors and agitator
- Manual mode for agitator, for sampling purposes.

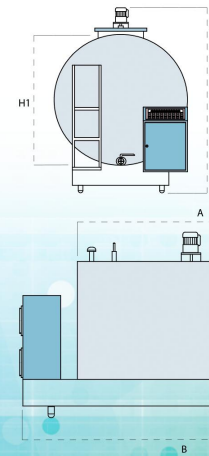

Hacim:	Kod:	A (mm)	B (mm)	C (mm)	H1 (mm)	H2 (mm)
3.000 Lt.	SAST/1	2500	4000	1450	1450	1850
4.000 Lt.	SAST/2	3000	4500	1450	1450	1850
5.000 Lt.	SAST/3	3000	4500	1650	1650	2050
6.000 Lt.	SAST/4	3000	4500	1750	215	1750
8.000 Lt.	SAST/5	3500	4500	1850	2250	1850
10.000 Lt.	SAST/6	4000	5500	1970	2450	1970

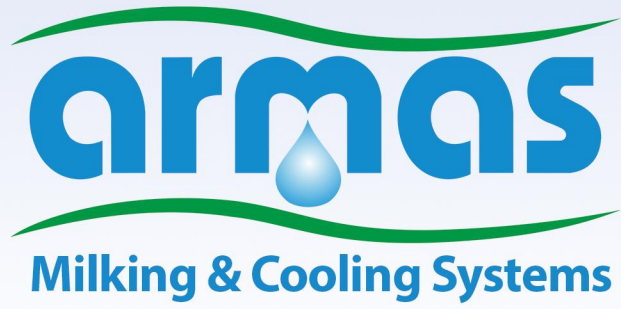

Address: Bekir Saydam Street No:104 B/6 Block No:1-2 Ayrancılar - İZMİR - TURKEY
Contact: +90 (0232) 868 52 50 Pbx - +90 (0232) 868 52 57 **Fax:** +90 (0232) 868 52 57
www.armastarim.com.tr - info@armastarim.com.tr